

ICSO 2016

International Conference on Space Optics

Biarritz, France

18–21 October 2016

Edited by Bruno Cugny, Nikos Karafolas and Zoran Sodnik



Sentinel-3a: commissioning phase results of its optical payload

J. Nieke

C. Mavrocordatos



International Conference on Space Optics — ICSO 2016, edited by Bruno Cugny, Nikos Karafolas,
Zoran Sodnik, Proc. of SPIE Vol. 10562, 105620C · © 2016 ESA and CNES
CCC code: 0277-786X/17/\$18 · doi: 10.1117/12.2296174

SENTINEL-3A: COMMISSIONING PHASE RESULTS OF ITS OPTICAL PAYLOAD

J. Nieke¹, C. Mavrocordatos¹ and the S3 team

¹European Space Agency, European Space Research and Technology Centre, Keplerlaan 1, 2200 AG Noordwijk ZH, The Netherlands

I. INTRODUCTION:

The Sentinel-3 (S3) is a Global Land and Ocean Mission [1] currently in development as part of the European Commission's Copernicus programme (former: Global Monitoring for Environment & Security (GMES) [2]).

The multi-instrument Sentinel-3 mission measures sea-surface topography, sea- and land-surface temperature, ocean colour and land colour to support ocean forecasting systems, as well as environmental and climate monitoring with near-real time data.

The Sentinel-3A (S3A) satellite, the first of a series of four satellites, was launched on the 16th of February 2016 and the Sentinel-3B satellite is planned to be launched with 2017. Two Sentinel-3 C and D satellites are in development as replacement units for the A and B satellites that collectively provide a 20-year period of continuous observations.

In this paper we describe the S3A optical payload and summarize the first commissioning phase results.

A. Sentinel-3 orbit and spacecraft

Even though each of the S3 satellites is carrying a large instrument package (five instruments), the spacecraft (S/C) is of moderate size (mass ~1300 kg, 3.9 m high) to be compatible with Rockot or Vega class launch systems. The lifetime of one satellite is designed for at least 7.5 years in-orbit. An overview about the S3 orbit parameters is given in the following table Tab. 1. Fig. 1 shows the S3A satellite fully equipped during on-ground testing.

Tab. 1. Sentinel-3 satellite orbit parameters

Orbit type	Repeating frozen sun synchronous low Earth orbit
Repeat cycle	27 days (14 + 7/27 per day)
Local Solar Time	10:00 a.m. at descending node
Average altitude	814.5 km
Inclination	98.65°
S3B satellite	Identical orbit to S3A but flown 140° out of phase with S3A.



Fig. 1. The Sentinel-3A satellite fully equipped during on-ground testing at Thales Alenia Space, France, in December 2014.

B. Sentinel-3 Payload

The S3 instrument package includes two optical payloads and an altimetry topography payload package:

1) Sentinel-3 optical payloads:

a) A Sea and Land Surface Temperature Radiometer (SLSTR), that uses heritage concepts taken from ENVISAT's Advanced Along Track Scanning Radiometer (AATSR), will determine global sea-surface temperatures to an accuracy of better than 0.3 K. The SLSTR improves the dual-view along-track-scanning technique of AATSR to provide advanced atmospheric correction. SLSTR has a much wider swath at nadir (1440 km) and an oblique (i.e., backward orientated) view (720 km) compared to the (A)AATSR series. SLSTR also measures in nine spectral channels with two additional bands optimised to monitor fire. The SLSTR has a spatial resolution in the visible and shortwave infrared channels of 500 m and 1 km in the thermal infrared channels.

b) An Ocean and Land Colour Imager (OLCI) that is based on a heritage design from ENVISAT's Medium Resolution Imaging Spectrometer (MERIS). OLCI has 21 bands, compared to the 15 on MERIS, an observation geometry optimised to minimise the negative impact of sun-glint, and a spatial resolution of 300 m over all surfaces. The swath of OLCI is fully overlapping with the SLSTR near-nadir swath to enhance synergy-processing capabilities. OLCI marks a new generation of moderate resolution multi-spectral measurements over the ocean and land.

2) Sentinel-3 altimetry topography payload package:

A dual-frequency (Ku and C band) advanced Synthetic Aperture Radar Altimeter (SRAL) that is based on CryoSat SIRAL and ENVISAT RA-II heritage. SRAL provides measurements at a resolution of ~300m in Synthetic Aperture Radar (SAR) mode along track (note that the width of the footprint is dependent on the surface roughness and varies from ~2 km - >20 km over the ocean depending on sea state). SRAL is supported by a Microwave Radiometer (MWR) to provide a wet-troposphere atmospheric corrections and by Precise Orbit Determination (POD) instrumentation, comprising a Doppler Orbitography and Radiopositioning Integrated by Satellite (DORIS) receiver a dual-frequency GNSS receiver and a Laser Retro-Reflector (LRR).

The Sentinel-3 topography package provides exact measurements of sea-surface height, which are essential for ocean forecasting systems and climate monitoring. SRAL also provides accurate topography measurements over sea ice, ice sheets, rivers and lakes.

C. Sentinel-3A Operations

The S3 operations concept is built around the principle of a quasi-autonomous satellite with minimum human intervention to simplify mission management and operations. Spacecraft and payload operation commands can be stored on-board in a dedicated OPS (Orbit Position Scheduler) covering a period equivalent to the full 27-days satellite orbital repeat cycle. Execution of commands stored in the OPS are triggered based on the geographical location, making it possible to select a particular measurement mode depending on the surface over which the spacecraft is flying. The commanding profile is periodic from one repeat cycle to the next and any upload of new commands is only needed to cover non-routine events (e.g. changes in the calibration timeline, seasonal changes of the ice extent etc).

Fig. 2 provides an overview of the main elements of the S3 operation concept highlighting where and when each instrument is operated around the orbit. The payload instrument duty cycles vary around each orbit:

- SRAL, MWR and SLSTR data acquisitions are performed without interruption over the entire orbit,
- No SLSTR visible channel data will be acquired during eclipse and OLCI data acquisitions are only made when the solar zenith angle is smaller than 80°,
- Solar calibrations of OLCI and SLSTR are performed during the terminator crossing in the southern hemisphere,
- SRAL Low Resolution Mode (LRM) and Synthetic Aperture Radar (SAR) mode can be commanded alternatively according to requirements managed by mission planning. The current baseline foresees to operate SRAL in SAR mode continuously and to make use of LRM as a backup.

The projected sensing duty cycle per orbit for all Sentinel-3 instruments is 100% (i.e., for the MWR, SLSTR, SRAL in SAR-mode, GNSS/DORIS and NAVigation and ATTitude (NAVATT)) except for OLCI. OLCI's duty cycle is 44% sufficiently allowing a full-resolution data acquisition for solar zenith angles smaller than 80 deg.

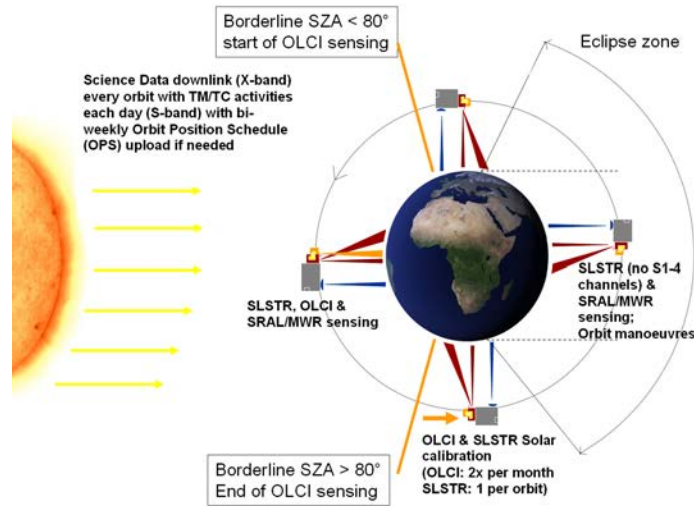

Fig. 2. Sentinel-3 operations and instrument payload acquisition overview. Blue indicates SRAL/MWR, red SLSTR and orange OLCI planned data acquisitions (SZA stands for solar zenith angle).

The Earth is observed by OLCI and SLSTR in common collocated swaths. Whereas the OLCI and SLSTR nadir field-of-views have a slight offset to the west of the nadir position, the SLSTR oblique view is centred on the nadir ground track of the satellite. Also the footprints of SRAL and MWR are directed to nadir, on the satellite ground track (see Fig. 3.).

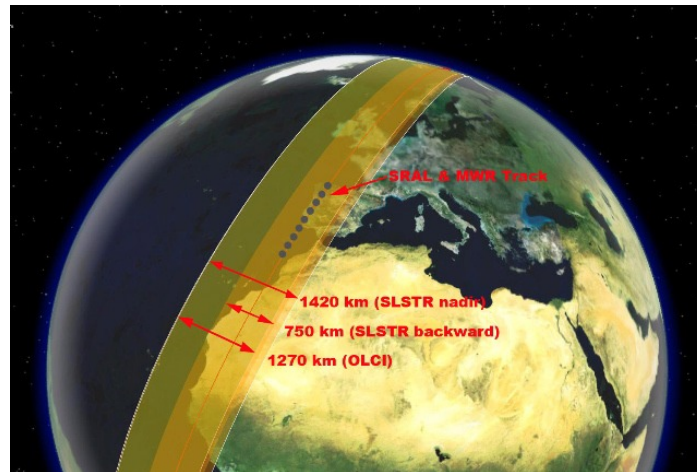

Fig. 3. Ground swath of OLCI and SLSTR (nadir and oblique) and the centrally nadir located footprint of the SRAL and MWR.

II. Ocean and Land Colour Imager (OLCI)

The primary goal of the OLCI is to provide global and regional measurements of ocean and land surface at a high level of accuracy. The OLCI instrument is based on the opto-mechanical and imaging design of ENVISAT-MERIS [3, 4] with key characteristics described in Tab. 2.

In contrast to the MERIS instrument, OLCI employs an asymmetric swath with respect to the satellite ground-track in order to avoid direct solar reflection at sea surface (sun-glint). The amount of tilt is defined by the need to minimize the maximum Observation Zenith Angle (OZA) at the outer border of the swath and at the same time guaranteeing global coverage. Figure 6 shows the across-track tilt of the overall field of view of 12.6° , resulting in a maximum OZA slightly above 55° .

Tab. 2. Technical characteristics of the S3 OLCI instrument [5].

Swath	~1270 km
Spatial Resolution	300 m @ Sub-Satellite Point (SSP)
Calibration	MERIS type calibration arrangement with spectral calibration using a doped Erbium diffuser plate, radiometric calibration using PTFE diffuser plate and dark current plate viewed approximately every 2 weeks at the South Pole ecliptic. A second diffuser plate viewed periodically for calibration degradation monitoring.
Detectors	ENVISAT MERIS heritage back-illuminated CCD55-20 frame-transfer imaging device (780 column by 576 row array of 22.5 μm square active elements).
Optical scanning design	Push-broom imaging spectrometer. 5 cameras recurrent from MERIS with dedicated Scrambling Window Assembly and supporting by 5 Video Acquisition Modules (VAM) for analogue to digital conversion.
Spectral resolution	1.25 nm (sampling interval), 21 bands (nominal Earth View), 45 bands (spectral campaigns)
Radiometric accuracy	<2% with reference to the sun (0.1% stability for radiometric accuracy over each orbit and accuracy 0.5% relative accuracy for the calibration diffuser BRDF)
Mass / Size	150 kg / 1.3 m ³

OLCI observes the Earth with a Field of View (FOV) of more than 1200 km and an Instantaneous Field of View (IFOV) of 300 m at nadir over all earth surfaces that are illuminated by the sun. The data are delivered in 21 spectral bands with a high Signal-to-Noise Ratio (SNR) to provide continuity to data products generated by the 15 MERIS spectral bands. Six additional spectral bands in the spectral range between 390 and 1040 nm provide the means for improved water constituent retrieval (400 and 673.75 nm), atmospheric correction (1020 nm) and improved parameter retrieval in the O2A-band (760-775 nm).

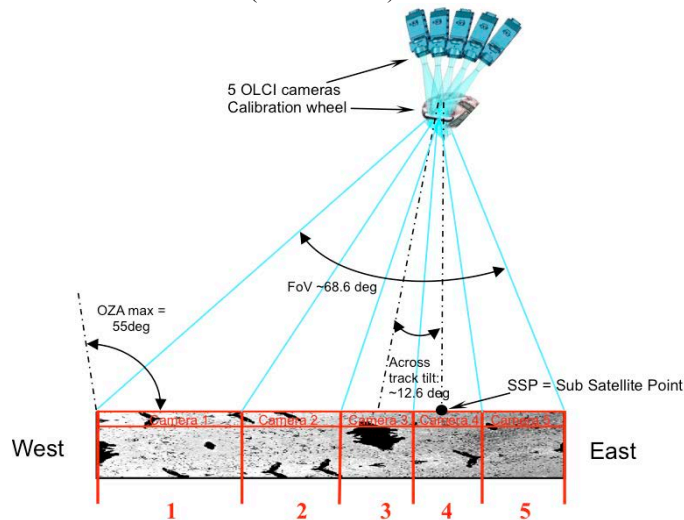

Figure 4: OLCI's 5 camera modules arranged in asymmetrical viewing geometry to avoid the sun reflection upon sea surface.

A. Optical Layout

The basic configuration of the OLCI instrument includes an optical bench supporting the following components (see Fig. 5b.):

- five fan-arranged Camera Optical Sub Assemblies (COSAs),
- five Focal Plane Assemblies (FPA), a Scrambling Window Assembly (SWA),
- five Video Acquisition Modules (VAM) containing the whole analogue imaging chain down to the digital conversion,
- OLCI Electronic Unit (OEU) managing all the instrument functions,
- calibration assembly allowing a radiometric and spectral calibration,
- heat pipe networks insuring the thermal control of the VAM,
- five FPA and detector.

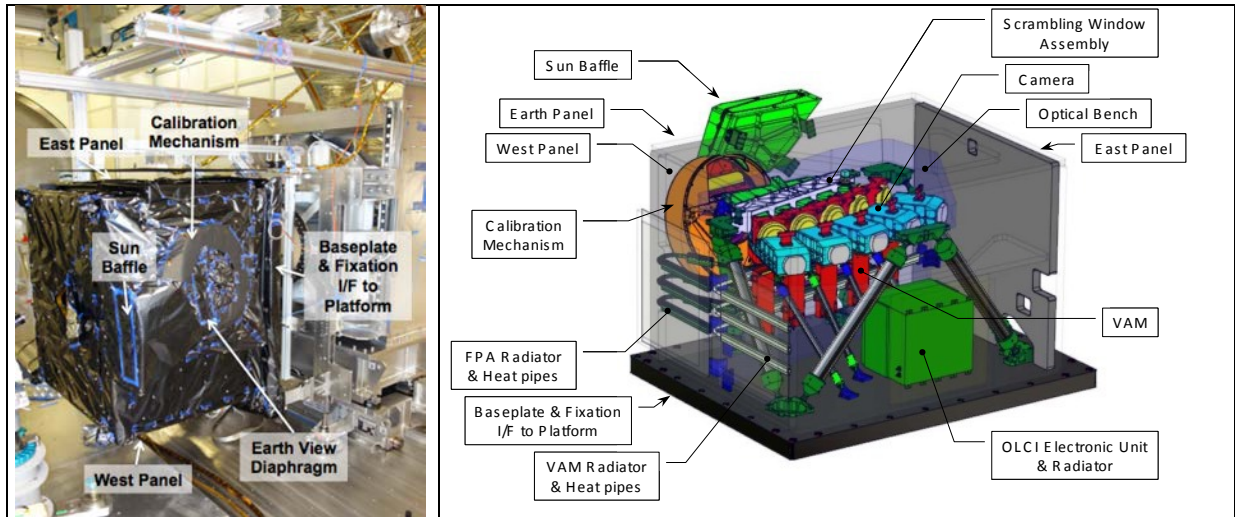

Fig. 5. a) OLCI-A in the instrument test configuration inside the vacuum chamber at Thales Alenia Space, France, b) OLCI Design Configuration Overview.

The optical layout of OLCI consists of a ground imager which is housed within the COSA box. The light is collected through the calibration mechanism (either from the Earth or the sun-illuminated diffusers) and the scrambling window. The collected light is focused onto the spectrometer entrance slit. The calibration mechanism allows a view of the Earth surface or one of several on-board calibration targets through a slit window by rotating each target mounted on a calibration wheel into the instrument FoV. Then the spectrometer generates a dispersed image of the slit on a 2-dimensional Charged Coupled device (CCD) array: one dimension of the array is the spatial extension of the slit, and the other dimension the spectral dispersion of the slit image in the range between 390 and 1040 nm.

B. First Results from OLCI

After the successful S3A Launch and Early Orbit (LEOP) and the Spacecraft-In-Orbit-Verification Phases (SIOV), the calval phase of the OLCI instrument started. The end of this Commissioning Phase is marked through the OLCI In-Orbit Commissioning Review (IOCR), which was held after 5 month in orbit. During the IOCR an in-depth assessment of the OLCI CAL/VAL activities (functional, performance, product verification and validation) was provided by all involved experts and centers confirming the overall excellent performance. In all aspects (radiometric, spectral and geometric), OLCI-A is performing well and data have been successfully assessed. Data assessment will continue and the temporal stability of the radiometric gain is an ongoing activity for which the ground processor needs to be updated and the BRDF model to be validated with in-flight characterization. Both activities are planned to be finalized by the end of the year 2016.

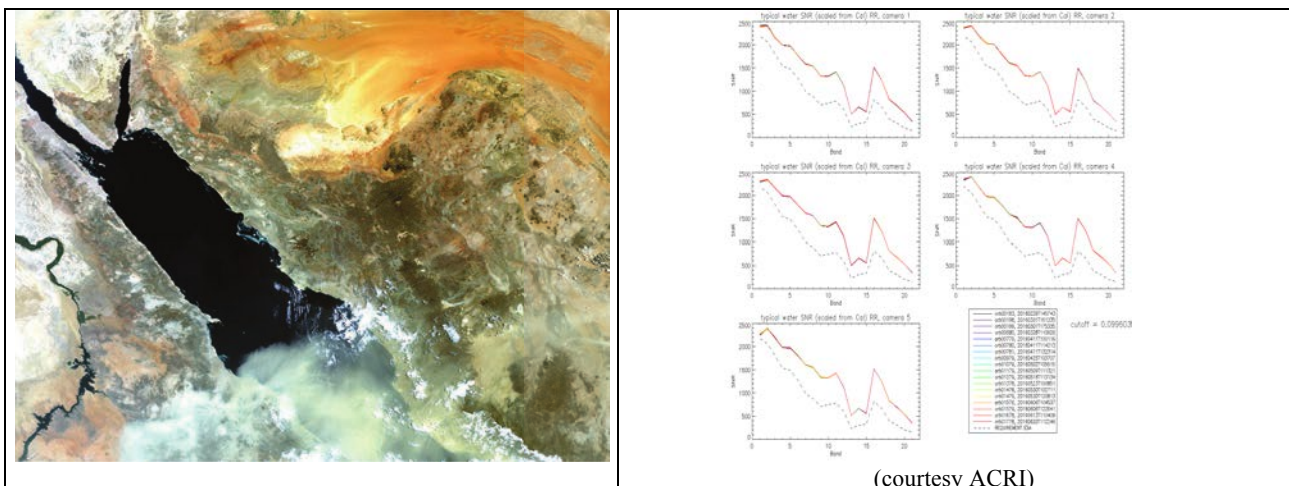

Fig. 6. a) OLCI-A capturing a large dust storm blowing east across the Red Sea on 25 July 2016. b) Excellent OLCI-A SNR performance for all modules (red lines) exceeding for most bands the specified SNR (black dashed lines).
Proc. of SPIE Vol. 10562 105620C-6

III. Sea and Land Surface Temperature Radiometer (SLSTR)

The Sea and Land Surface Temperature Radiometer (SLSTR) is an along-track-conical scanning dual-view radiometer, which provides data in nine spectral channels (S1-S9) plus two additional channels (F1-F2) optimized for fire monitoring.

The primary goal of the SLSTR is to determine global sea-surface temperatures to an accuracy of better than 0.3 K. The SLSTR instrument is based on the opto-mechanical and imaging design of the predecessors: Along-Track Scanning Radiometers (ATSR) on ERS-1 and ERS-2 [6] and Advanced Along-Track Scanning Radiometer (AATSR) on ENVISAT [7]. The key characteristics of the SLSTR are listed Tab. 3.

Tab. 3. Technical characteristics of the Sentinel-3 SLSTR instrument.

Swath	Nadir view 1400 km Dual view 740 km
Spatial Resolution	VNIR/SWIR channels: 0.5 km MWIR/TIR and fire: 1 km at Sub-Satellite Point (SSP)
Calibration	Two on-board calibration reference black bodies (BBs) and one Visible calibration unit (VISCAL) viewed respectively every 0.3 sec scan time (BBs) and once per orbit at the South Pole ecliptic (VISCAL).
Detectors	VIS: Silicon diode operational Temperature $T_{op} \sim 265$ K SWIR and Mid-Infrared (MIR): HgCdTe photovoltaic (PV) elements actively cooled to ~ 89 K, Thermal-Infrared TIR: HgCdTe photoconductive (PC) elements actively cooled to $T_{op} \sim 89$ K.
Optical scanning design	Along-track scanning based on two earth view scanning mirrors viewing two scan lines per revolution led via one recombination mirror and cooled focusing optics to the detector array (field stop on the detector elements)
Radiometric resolution	SNR (R/NeDR): >300 EOL in VIS at 30% reflectance & 0.5 km, SNR: 440-800 BOL in SWIR at 30% reflectance & 0.5 km, NeDT EOL < 60 mK in MIR & < 30 mK in TIR at 270 K & 1 km NeDT EOL < 90 mK in F1 & < 40 mK in F2 fire channels & 1 km
Radiometric accuracy	VIS-SWIR (albedo = 2-100%): $< 2\%$ (BOL) $< 5\%$ (EOL) MWIR-TIR (265-310 K): $< 0.1K$ (goal) Fire1 and fire2 (<500 K): $< 3K$
Mass / Size	ca 150 kg / 2.1 m³

A. Optical Layout of SLSTR

When compared to previous AATSR and ATSRs instruments, the SLSTR design allows a large near nadir and oblique view swaths (1400 and 740 km compared to the 500 km of AATSR) leading to improved global coverage and revisit time.

The SLSTR design permits two separate scans to increase the swath width, by means of two mirrors (instead of one for AATSR) inclined at $\theta=23.5$ deg with respect to the rotation axis with an half cone angle of $\beta=47$ deg: the inclined view rotation axis is pointed towards the sub-satellite point while the near-nadir view rotation axis is tilted backwards by $\gamma=41$ deg. This configuration ensures that all pixels are acquired with an Observation Zenith Angle (OZA) (see Fig. 6) of less than 55 deg, so that only the OZA dependency of the sea surface emissivity needs to be considered, while variations due to salinity, temperature and wind speed can be considered negligible. Further, the geometry provides a path length ratio between the two views (atmospheric optical thickness ratio) greater than 1.54 in order to maintain the same retrieval algorithms quality achieved by the algorithms applied to the data of the predecessors instruments.

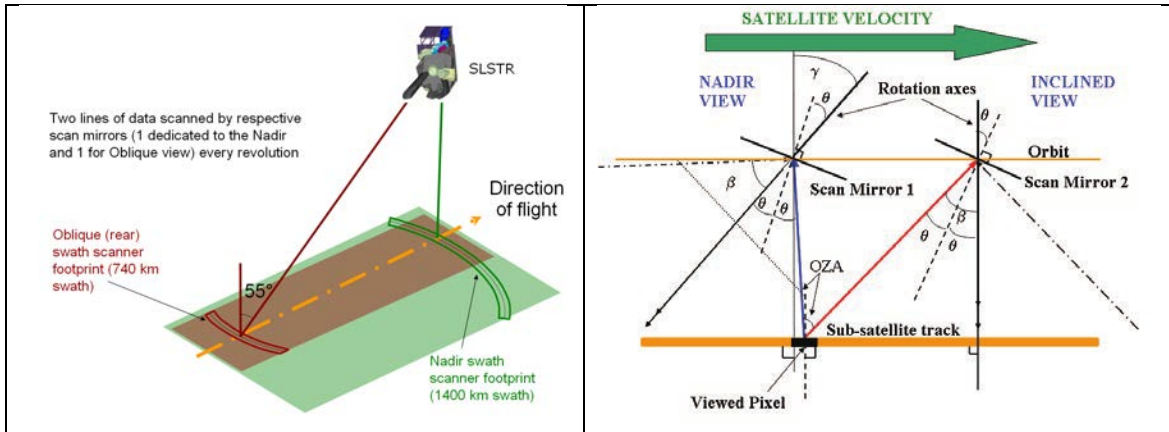

Fig. 7: a) Outline sketch of the SLSTR near nadir and oblique viewing geometry highlighting the asymmetric nadir swath with respect to the nadir point, b) Geometry of the SLSTR rotation axes of nadir and oblique views. Details of the SLSTR optical design were reported in [8]. The SLSTR comprises two physical units: first the SLstr Optical Scanning Unit (SLOSU), comprising the Opto-Mechanical Enclosure (OME) and the Detection Assembly (DA); second the Control & Processor Electronics (CPE) unit which controls all subsystems and manages the data interface with the satellite. OME forms the main instrument structure holding two telescopes (for near-nadir and backward views), the Scan Electronic Unit (SUE), the calibration units for the visible (VISCAL) and the infrared channels (Black Bodies (BBs) with associated Electronics Unit, BBEU) and radiators, while the DA comprises the Focal Plane Assembly (FPA) containing the focalizing optics and detectors, the Front End Electronics (FEE) and the Cryo-Cooling System (CCS).

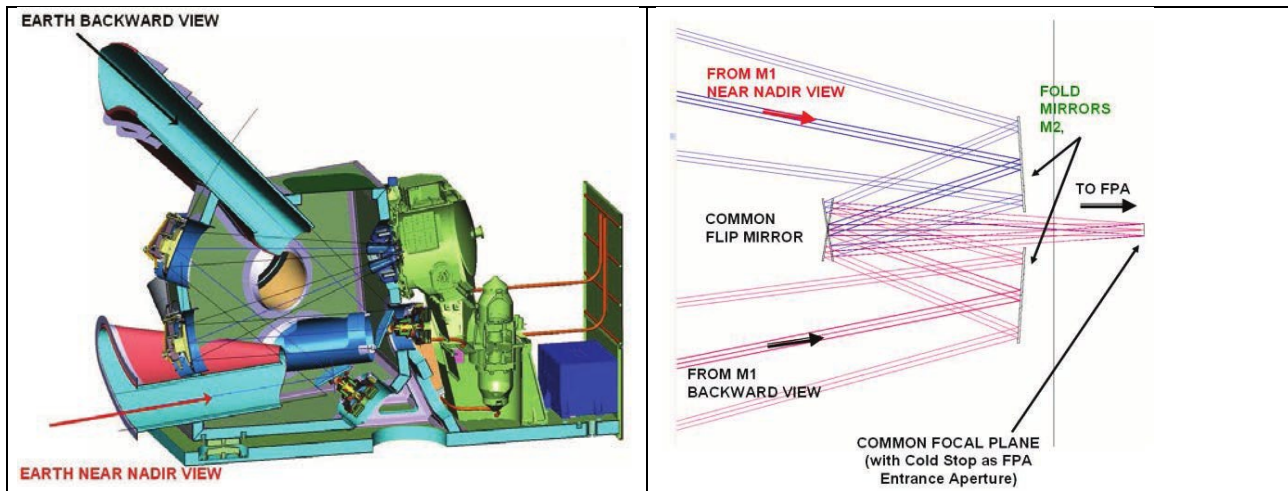

Fig. 8: a) SLSTR, consisting of two baffles, a scan mirror, an off-axis parabolic mirror and a folding plane mirror for each telescope (near nadir and backward view), b) A plane flip mirror is used to switch the beam between the two telescopes, focalizing at the entrance diaphragm of the Focal Plane Assembly (FPA), within which is separated into 9 spectral channels with cooled (265 K for VIS and 89 K for SWIR-TIR channels) dichroics, mirrors, filters, focalizing optics and detectors.

B. First Results from SLSTR

SLSTR-A went in operations shortly after the successful S3A Launch and Early Orbit Phase (LEOP) and the Spacecraft-In-Orbit-Verification Phase (SIOV). During the calval phase of SLSTR all functional, performance, product verification and validation was performed by involved experts and centers confirming – as for OLCI-A – the overall excellent performance. In all aspects (radiometric, spectral and geometric), SLSTR-A is performing well and data have been successfully assessed.

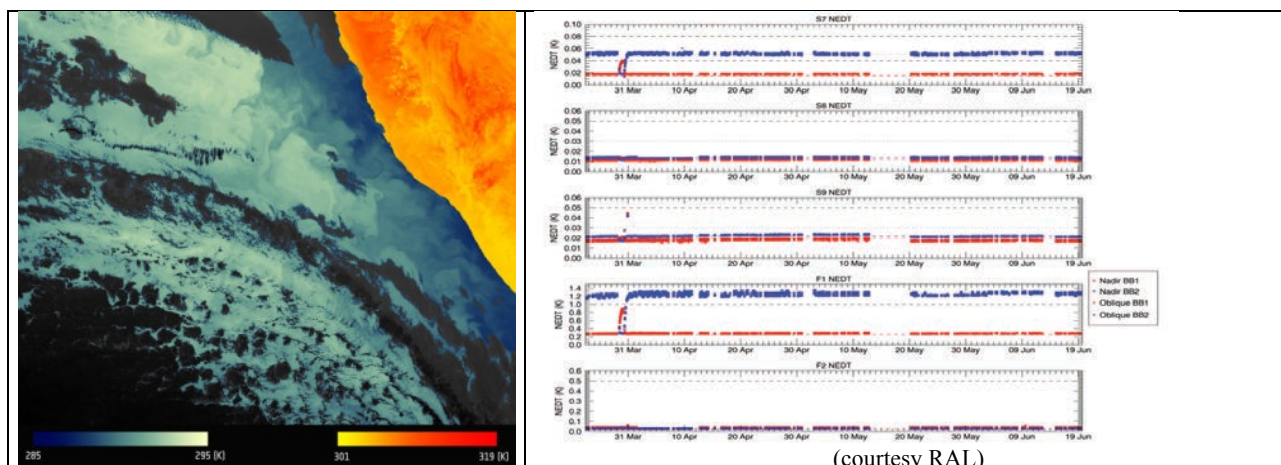

Fig. 9. a) SLSTR-A thermal-infrared channels depicting thermal signatures over a part of western Namibia and the South Atlantic Ocean. The Namibian land surface is shown in red–orange colours, corresponding to a brightness temperature range 301–319 K. The blue colours over the ocean correspond to a temperature range of 285–295 K b) Noise-Equivalent Delta Temperature (NEDT) of SLSTR-A channel S7 (3.7 μ m), S8 (10 μ m) and S9 (12 μ m) matching very well with specification and indicating initial long term stability.

IV. Conclusion

With the successful launch of Sentinel-3A, a new era for the Copernicus Services has started offering data over oceans and lands with unprecedented coverage. Together with Sentinel-3B, its twin satellite scheduled for launch in 2017, and later on with the replacement Sentinel-3C and D units, a 20-year period of continuous observations is guaranteed. Among the five instruments embarked, the OLCI and SLSTR optical payload ensure the continuity of the ENVISAT mission with very much improved performance. During the calibration-validation (calval) phase functional, performance, product verification and validation were performed confirming the overall excellent performance of the optical payload.

The calval phase was concluded successfully with an IOCR, which also confirmed the formal transfer of responsibility for the Sentinel-3A Space and Flight Operations Segments from the ESA Project Manager to the Sentinel-3 Mission Managers.

For its optical payload (SLSTR and OLCI), it was decided that science products become operational accessible after a small number of modifications of the ground processor and its related calibration update are performed. The plan is to release the optical data to its user community within 2016.

References

- [1] Donlon, C. et al, “The Global Monitoring for Environment and Security (GMES) Sentinel 3 mission ”, *Remote Sensing of Environment*, Vol. 120, p. 37-57, 2012
- [2] EC Copernicus site (<http://copernicus.eu>)
- [3] M. Rast, and J.-L. Bézy, “The ESA Medium Resolution Imaging Spectrometer MERIS: A review of the instrument and its mission”, *International Journal of Remote Sensing*, 20, 1681–1702, 1999
- [4] J.-L. Bézy, et al., “Medium Resolution Imaging Spectrometer for ocean colour on board Envisat,” in *Optical Payloads for Space Missions*, John Wiley & Sons, chapter 4, 2015
- [5] J. Nieke, et al., “Ocean and Land Colour Imager on Sentinel-3,” in *Optical Payloads for Space Missions*, John Wiley & Sons, chapter 10, 2015
- [6] Delderfield, D.T. Llewellyn-Jones, R. Bernard, Y. De Javel, E.J. Williamson, I. Mason, D.R. Pickand I.J. Barton, “The Along Track Scanning Radiometer (ATSR) for ERS-1”, *Proc. SPIE* 589,114-120, 1986
- [7] T. Llewellyn-Jones, M.C. Edwards, C.T. Mutlow, A.R. Birks, I.J. Barton and H. Tait, “AATSR: Global Change and Surface Temperature Measurements from ENVISAT”, *ESA Bulletin* 106, February 2001
- [8] Coppo, P., B. Ricciarelli, F. Brandani, J. Delderfield, M. Ferlet, C. Mutlow, G. Munro, T. Nightingale, D. Smith, S. Bianchi, P. Nicol, S. Kirschstein, T. Hennig, W. Engel, J. Frerick & J. Nieke, “SLSTR: a high accuracy dual scan temperature radiometer for sea and land surface monitoring from space,” *J. Mod. Opt.* 57(18), 1815–1830, 2010