

International Conference on Space Optics—ICSO 2000

Toulouse Labège, France

5–7 December 2000

Edited by George Otrio

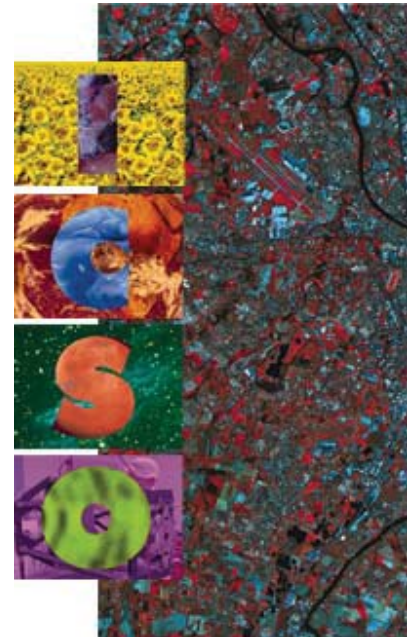

Very long stripe-filters for a multispectral detector

D. Laubier, Renaud Mercier Ythier



ics0 proceedings



VERY LONG STRIPE-FILTERS FOR A MULTISPECTRAL DETECTOR

D. Laubier (1)
R. Mercier-Ythier (2)

(1) CNES
18, avenue Edouard Belin
31401 TOULOUSE cedex 4

(2) SAGEM
Optique & Ingénierie - produits REOSC
61, rue Salvador Allende
92751 NANTERRE cedex

RESUME - Afin de simplifier les concepts instrumentaux, le Cnes a entrepris le développement d'un nouveau détecteur multispectral, comportant 4 lignes de 6 000 pixels de 13 μm et un filtre allumette devant chacune d'elles. Atmel a réalisé les démonstrateurs de détecteurs, et Sagem/Reosc les filtres. Deux voies d'assemblage ont été évaluées : la première directement sur le boîtier (Atmel), la seconde par collage optique sur la fenêtre de ce dernier (Seso). On présentera ici les résultats de l'étude comparative technologique, ainsi que les performances des filtres allumettes. Le concept d'assemblage impose certaines contraintes sur le dimensionnement des filtres et des détecteurs, en particulier en ce qui concerne la sensibilité à la lumière parasite. On en donnera les principes, et on comparera les résultats de modélisation aux mesures.

ABSTRACT - In order to simplify instrument design, a new linear area CCD sensor has been developed under CNES responsibility. This detector has four lines 6000 13- μm square pixels long with four stripe filters, one in front of each of them. The detector itself was manufactured and mounted by ATMEL, and the filters were made by SAGEM/REOSC. Assembly was done in two ways, one by ATMEL, the other by SESO. CNES was responsible for the overall design and mechanical/optical interfaces. This paper reports the optical part of this work, including filters placement strategy and line spacing. It will be shown how these two features are closely linked to straylight performance. First, a trade-off study was conducted between several concepts: the results of this study will be presented, as well as the filter design and manufacturing results. They show good transmission and excellent rejection. Final performance of the complete prototypes has been measured, and it will be compared to theoretical models.

1 - INTRODUCTION

For future low cost Earth Observation missions, CNES has been working since 1995 on instruments with TMA type telescopes (three-mirror anastigmat) which give high image quality over wide fields of view (FOVs) with important folding, thus smaller dimensions. For instance, a mission such as Spot follow-on (resolution 2 to 3 m, swath 40 to 60 km, one panchromatic and four bands in the visible/near infrared part of the spectrum) only requires one small satellite with one camera.

However, as they are purely reflective systems, these telescopes can no longer admit plain glass spectral beam-splitters, because they cannot compensate for the chromatic aberrations those

introduce. It is now necessary to separate the different spectral bands in the FOV. For this purpose, after the demonstration of the TMA, CNES has realized the prototype of a multispectral detector made of four 6000-pixel linear array CCDs on the same chip. This detector would be placed in the focal plane of a TMA along with a panchromatic detector. This paper describes the technical solutions imagined for the optical filters and the one that has finally been retained. It will focus on how this particular technology impacts on the definition of the detector itself.

2 – FOCAL PLANE ASSEMBLY TRADE-OFFS

With the detector lines parallel to each other, the only possible location for the filters is between the detector and the distance at which the optical beams begin to cross, as illustrated in Fig. 1.

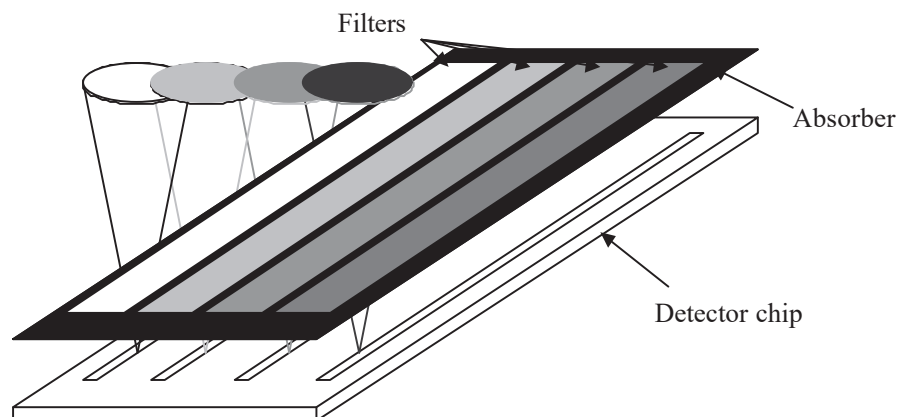

Fig. 1: the multispectral detector.

For standard, commercial detectors, colored polymers are deposited directly on the pixels. But they are not very flexible, show rather poor rejection and their spectral response tends to degrade with time (even under normal use). In order to guarantee the stability of the filters under space environment, we have chosen to adapt space-qualified multilayer coatings.

The assembly could take several forms, whose major advantages and drawbacks are listed in Tab. 1. They are:

- direct deposition of the coating on the chip, (1)
- assembly of four narrow filters on the chip, (2)
- assembly of a single substrate with four stripe-filters on the chip, (3)
- assembly of a single substrate with four stripe-filters on the detector package, (4)
- assembly of four narrow filters over the detector window, (5)
- assembly of a single substrate with four stripe-filters over the detector window. (6)

Direct deposition on the chip is the most natural solution, but was considered too risky because it combines different technological processes (optical thin films and electronics) with possibly low fabrication yield or incompatibility with each other. Assembly of one or several filter substrates on the chip was also seen as a very difficult operation given the dimensions (80 mm long and less than 1 mm wide) of the pieces. Pluses and minuses were awarded in the straylight column according to the distance between the detector and the filters. Apart from the local defects in the filters, the higher the distance, the worse the straylight. Last, we considered that filters performance and yield were better when they are manufactured on different substrates.

Solution \ Criterion	Processes compatibility	Technological maturity	Straylight performance	Filters performances
(1)	--	--	++	-
(2)	-	-	+	++
(3)	-	-	+	+
(4)	+	+	--	+
(5)	+	-	-	++
(6)	++	++	-	+

Tab. 1: advantages and drawbacks of the different assembly solutions.

Facing with the low cost target (i.e. putting a higher weight on technological maturity), the preferred solutions were to deposit the four stripe-filters on a single substrate that would be either used as the protection window of the detector package (4), or glued over the window (6). The former exposes the filters to the hard environments seen during the detector assembly and qualification process. Also, using standard industrial processes, the latter provides a better alignment precision and thus a better straylight control, as will be seen next. So (6) was our nominal solution, but (4) was also worth trying as a backup solution. These solutions present the advantage of using a well known package assembly process where contamination problems for instance can be surely controlled.

3 – THE STRAYLIGHT ISSUE

The two solutions under examination have this difference with the others that the filters are relatively far from the detector, and that they must take into account not only the detector width but also the beam size on the filters, which is in our case much larger. The problem arises from the fact that outside the pixels themselves, the detector surface is coated with an aluminum film that is highly reflective. So the light passing through the filters and reflecting nearby the pixels on this film can be reflected back on the filters to the pixels, as illustrated Fig. 2. This is what we will call infraband straylight.

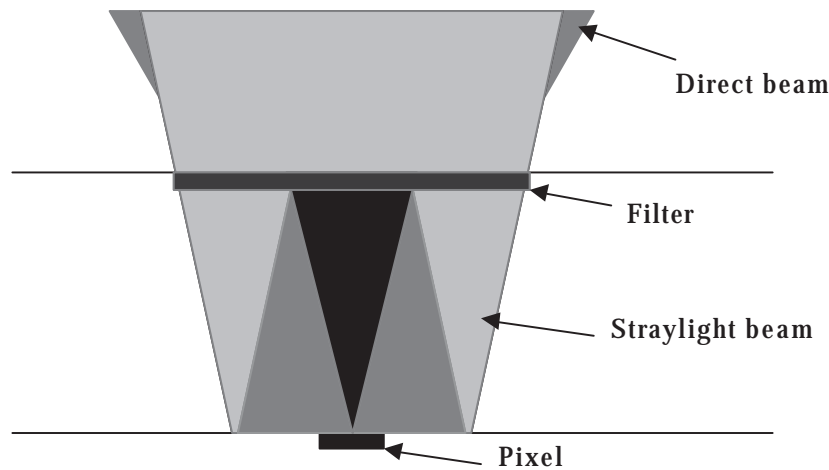

Fig. 2: infraband straylight.

This phenomenon is not negligible because the filters are not 100 % transmissive at their top and do not have infinitely steep slopes, so that the reflectivity is far from 0. There are other reasons.

First, the detector surface is not perfectly flat: measurements of the light reflected have shown that it has a certain roughness, and also that the readout registers behave like a plane grating. These two phenomena generates straylight over a wide angular range.

Second, when this lights hits the filters with this high incidence, the filter spectral response shifts to the shorter wavelengths, so that the long wave slope of the filter moves to the shorter wavelengths (see Fig. 3). For a narrow band or for the upper part of a wide band, transmission at the filter can now be as low as 0 %, i.e. reflection = 100 %.

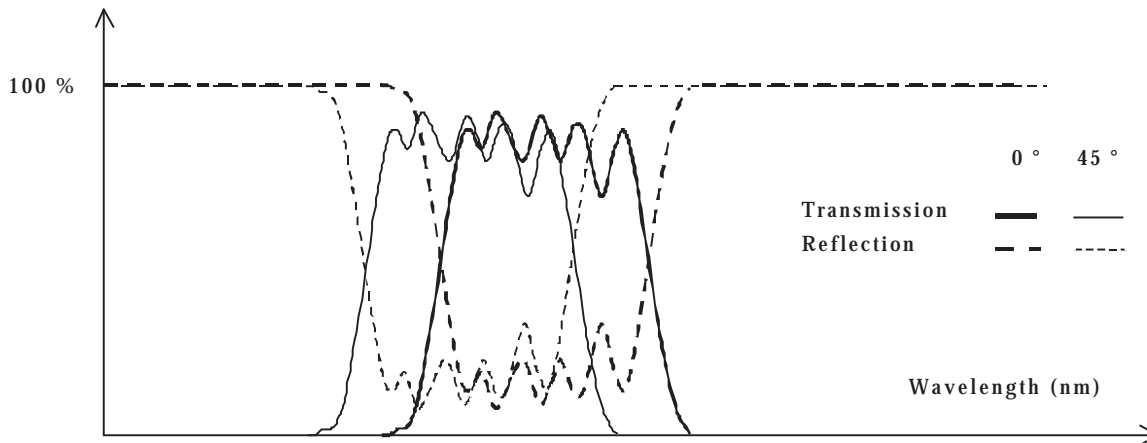

Fig. 3: spectral shift at non-normal incidence.

The consequence is that it is most important to minimize light entrance: for this purpose, an absorbing coating must be placed between the four filters to block useless light. The size of the filter aperture is given by the pixel and beam sizes, a margin to account for the possibility that the incidence on the focal plane slightly changes after the telescope alignment, and of course a tolerance on the filter positioning. That is what makes (6) more interesting than (4), because in the standard space detector packaging process (that can hardly be changed at low cost), only a moderate precision is needed.

Also, on its inner side, the absorbing coating must have the lowest possible reflectance in order to prevent light entering one band from reaching the next one (interband straylight). Design insures that all such straylight can occur only after one attenuation on this coating (see Fig. 4).

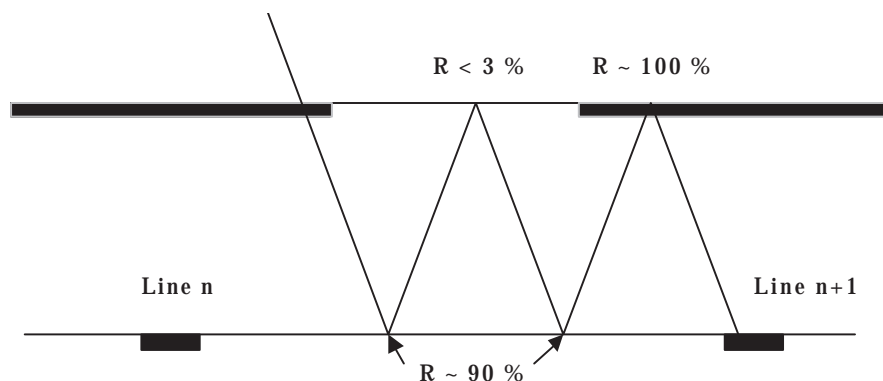

Fig. 4: interband straylight.

With the filter and absorber designed, the spacing between the detector lines is set to a value generally higher than what the electronics can do.

For our two solutions, the result is of course different. But for the demonstration, it was not possible to manufacture two detector batches, and one common spacing was chosen, but with two filter sizes. Thus, because it is much larger than interband, infraband straylight is minimized in both solutions, leaving the interband a little better in solution (6).

Straylight level is characterized by the following ratio: the instrument looks at the frontier between two regions, one of luminance L , the other completely dark. Infraband straylight ratio is the ratio of the signal coming from a pixel observing the dark region over the signal coming from a pixel observing the bright region, when the frontier is perpendicular to the detector lines, at any place along a line. Interband straylight ratio is similar, with the difference that the frontier is now parallel to the lines and the bright region covers the first 3 lines while the dark region covers the last one.

Tab. 2 gives the estimated straylight ratios in the two configurations. These figures are to be compared to a global acceptance level of 8%.

	(4)		(6)	
	Bands B_0, B_1, B_2	Band B_3	Bands B_0, B_1, B_2	Band B_3
Infraband	10 %	8 %	7 %	5.5 %
Interband	1.45 %		1.1 %	

Tab. 2: straylight performance in the two cases.

The total infraband straylight comes from multiple reflections on all the different optical surfaces, but the major contribution comes generally from the reflection (either specular or diffracted) between the detector surface and the filters. In the case of band B_3 , another important contribution comes from the first surface (the wide band blocking filter): this is due to the fact that the right slope of this band is made by this filter. As it is farther away from the detector than the filter, the *étendue* of this straylight path is smaller, and so is the straylight ratio.

Multiple reflections between the blocking and the filters can be regarded as negligible compared to the previous ones.

For the interband term, the major contribution arises from the geometric configuration. In a group of three lines, two of them are symmetric about the central one. So light entering the first band and being diffracted perpendicularly can reflect on the filter located over the second line directly to the third one, with about 100 % reflectance. Fortunately, the optical *étendue* of this path is rather small.

4 – THE STRIPE-FILTERS

4.1 Filters description

In 1999, several batches of filters have been manufactured by SAGEM, according to the designs (4) and (6). Fig. 5 shows the overall filters' design, whose main characteristics are recalled in Tab. 3.

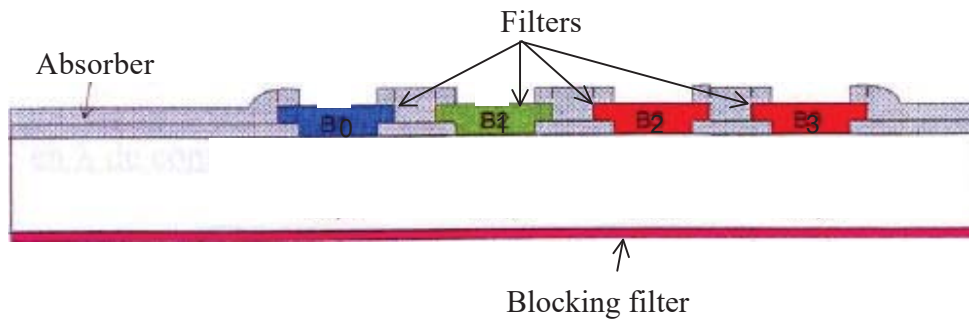

Fig. 5: overall design.

Parameter	Specification
Substrate	BaK50
Dimensions	Overall dimensions : 1.1 x 106.5 x 19 mm +/- 20 μm Band dimensions : 375 μm or 475 μm +/- 2 μm depending on the kind of filters, for a length of 82.8 mm
Central λ	480 nm, 550 nm, 660 nm and 840 nm
Minimum BWHM	80 nm for the 3 first bands, 125 nm for B ₃
Average transmission	>90 %, uniformity within 2%
Max slope width	40 nm for B ₀ , 50 nm for the others
Absorber max transmittance	10 ⁻³ over [350, 1100 nm]

Tab. 3: filters main characteristics.

The spectral specifications were quite tight for this kind of filters. As a matter of fact, a large number of layers were required to fulfill the requirements. But the overall height of the filter had to be limited to be compliant with the manufacturing process and to allow the overlapping of the absorber. Therefore, a compromise had to be found.

Each filter was composed of a high-pass filter and a low-pass filter. For B₀, the high-pass was made by the blocking filter, located on the other side of the component. For B₃, the low-pass filter was also made by the blocking filter. This also tends to lower the reflection coefficient on the filters, and so the straylight level.

The coating technology used for the strip-filters has been developed by SAGEM during these last years for the manufacturing of space components. It has been space qualified in the scope of many programs (SILEX, HELIOS, SPOT, Indian instruments IRS...) and guaranty a very good stability in a space environment. This technology has also allowed to develop a blocking filter coated on only one diopter, instead of two as it was performed previously.

The tight tolerance on the band dimensions (2 μm) has led to the choice of the lift off technology to manufacture the filters. This technology is described hereunder.

4.2 Filters manufacturing

The filters are done by lift-off technology (see Fig. 6). The lift-off allows to obtain a very good accuracy on the definition of the bands dimensions, especially for the absorber coating which defines the filters' stop. It is compliant with the 2 μm tolerance on the stop dimensions.

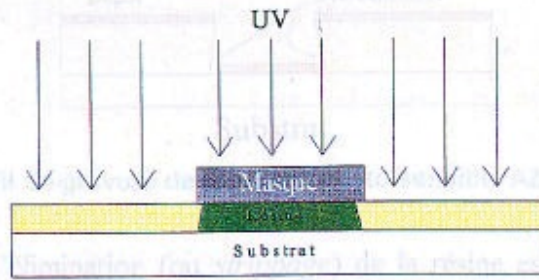
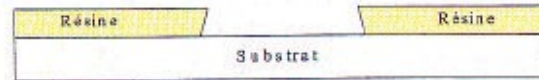
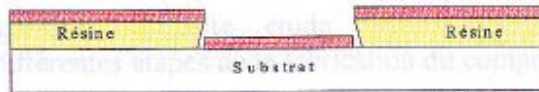
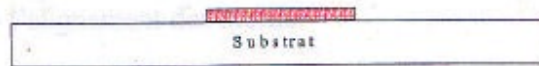
1- ENDUCTION & INSOLATION RESINE**2- DEVELOPPEMENT RESINE****3- EVAPORATION CM****4- STRIPPAGE RESINE****Fig. 6:** lift-off technological process.

A photosensitive resin is used to define the mask of each band. First, the resin is lighted by UV radiation. The area where the filters shall be deposited is protected by a mask during this operation. Then, the resin is developed and the protected resin is removed. During the next step, the filter is coated all over the component. Finally, the stripping is performed. The resin remaining on the substrate is removed and the coating remains only at the planned location. All these operations shall be repeated 5 times for manufacturing this component, once per coating. The result is presented on the photograph in Fig. 7.

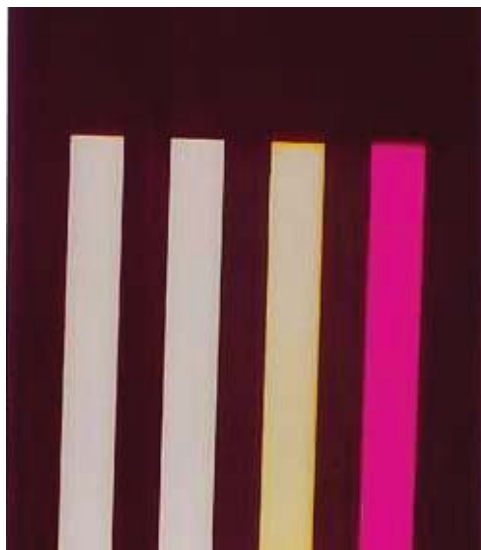
**Fig. 7 :** strip-filter manufactured by SAGEM in 1999.

4.3 Qualification results

A space qualification has been performed on the filters in 1999. This qualification included the following environmental tests :

- ✓ Thermal cycling ($-40^{\circ}\text{C} / +60^{\circ}\text{C}$),
- ✓ Humidity (95% at $T=40^{\circ}\text{C}$),
- ✓ Thermal vacuum ($-40^{\circ}\text{C} / +60^{\circ}\text{C}$),
- ✓ Hot storage (2 hours at 150°C).

Between each test, different measurements have been performed including visual inspection, adhesion test and spectral measurements.

For the spectral measurements, a microspectrophotometer has been used to measure spectral transmission of the filters on small areas. This instrument has been specified by SAGEM/REOSC and manufactured by Jobin-Yvon. It includes a monochromator coupled with a microscope lens assembly. A monochromatic spot of diameter between 10 and 100 μm can be obtained. This instrument has been used, first, to measure the uniformity of the filters and, second, to define the consequences of small defects on the spectral transmission.

After coating, the dimensions and the spectral characteristics of the components have been measured. All the dimensions have been found within the requirements. This demonstrates the quality which can be obtained with the lift-off process.

The spectral results obtained after coating are given in Fig. 8. Except for B_0 whose average transmittance is a little lower than the specification, the spectral performances have been obtained. The uniformity measured with the microspectrophotometer was also within the 2% specified.

Concerning B_0 , the transmittance is first limited by the absorptance of the thin layers in the UV domain (6% to 8% under 480 nm) and also by the performance of the high-pass filter, realized by the blocking coating on the other face of the component. To obtain a better performance, one solution could be to use two diopters for the blocking coating.

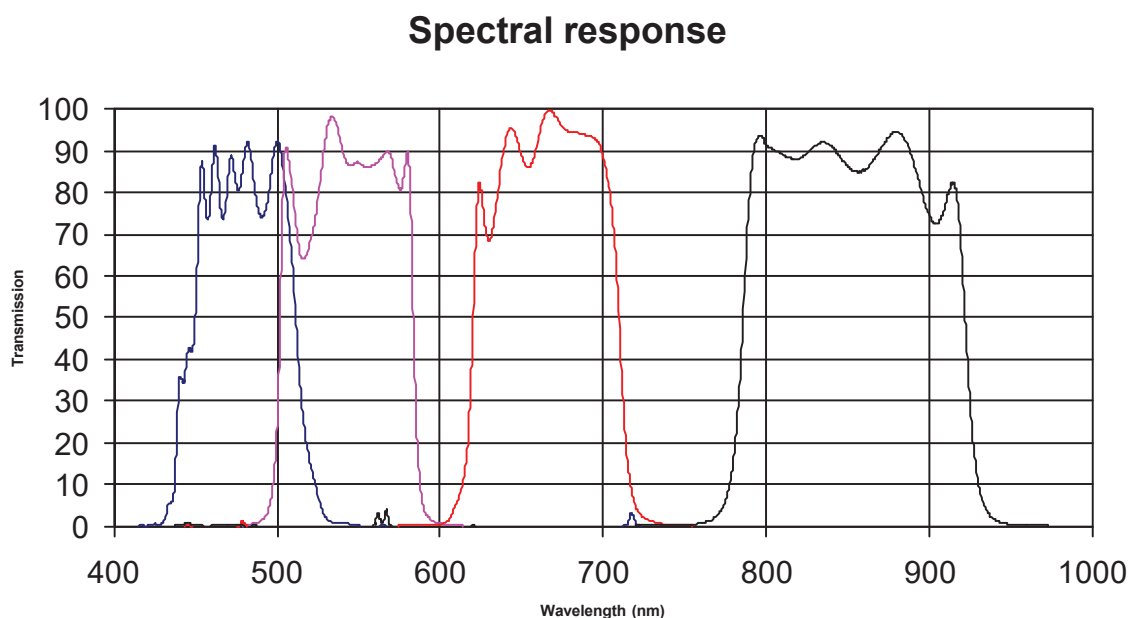

Fig. 8 : strip-filters spectral response.

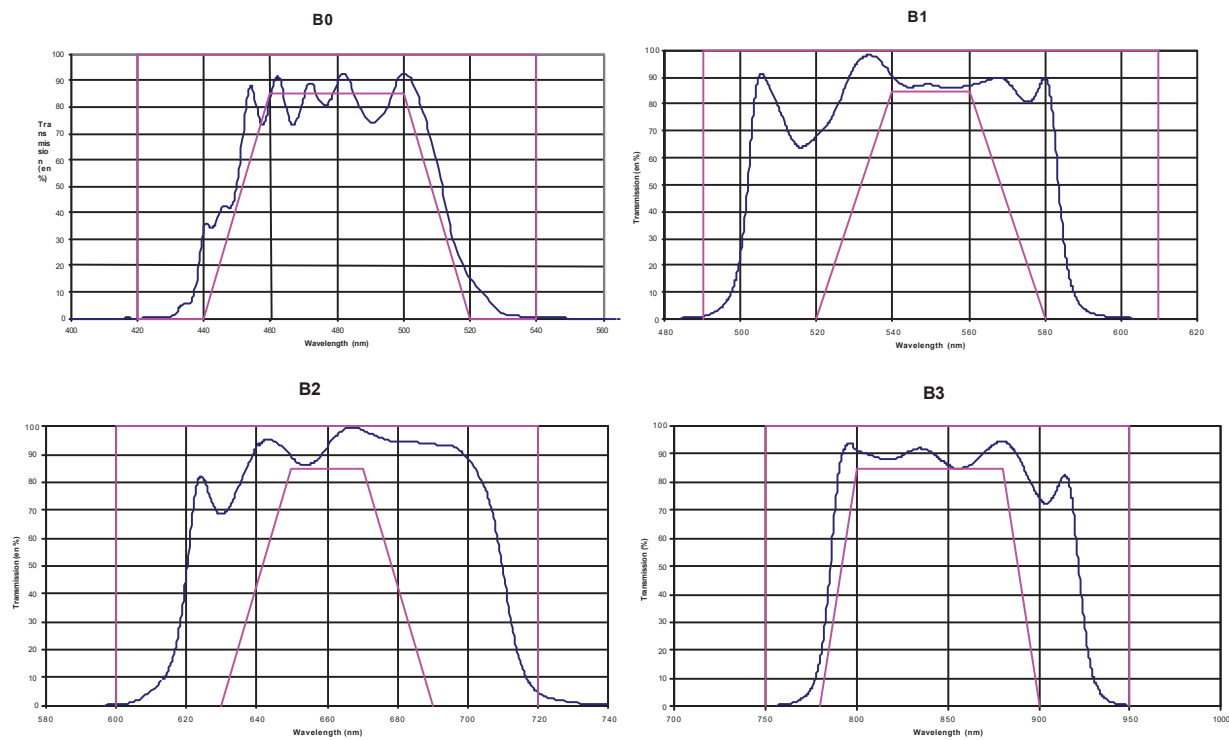

Fig. 9 : comparison to specification.

The spectral transmittance has also been measured for different local defects. The purpose of this test was to better estimate the consequence of small defects on the filter performances, in order to define a specification compliant with the scientific needs and the manufacturing know-how.

Since the stripe-filters are close to the image plane, local defects can degrade the spectral performance for the pixels in front of the defects. Fig. 10 gives the measurement obtained for different kinds of defects, when using a spot size of 100 μm for the microspectrophotometer

Spectral measurements

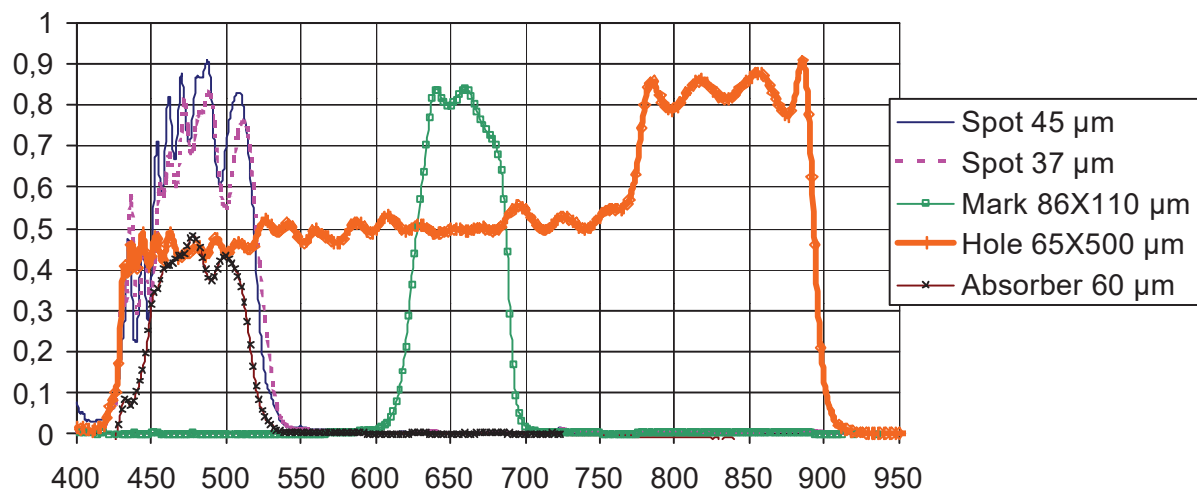

Fig. 10: effects of local defects on the spectral response.

It shows that the consequence of spots is mainly to attenuate the spectral transmittance. In the rejection band, no consequence is observed. The consequences for the overall system will therefore

be a lower signal for the few pixels concerned by these defects. This attenuation is not necessarily critical, even for large defects like the mark on the previous graph. On the contrary, holes have two influences. The transmittance is lowered inside the bandwidth, and is strongly increased outside the rejection band. This can lead to cross-talk between channels. Therefore, holes are more critical and their number and size shall be limited.

After initial measurements, the components have been submitted to space qualification. All the bands have successfully passed these tests. The adhesion tests performed at the end of the qualification showed no non conformity.

5 – FIRST RESULTS

Straylight measurements are a difficult task, because they must be made in conditions as close to reality as possible: that means aperture angle, spectral band, optical bench alignment, etc.

Detectors of types (4) and (6) have been assembled by Atmel and Seso. The results are still preliminar and under close examination, but first observations that were made on interband straylight confirm some of the phenomena we expected, and their level.

Considering the thermo-mechanical aspect, tests made on mock-ups for type (4) and on the first prototypes for type (6) confirm that the environment seen during detector closing are too harsh for the filters, and that uncoupling the detector and filters manufacturing processes is the easiest way.

6 – CONCLUSION

This study has allowed to manufacture and to qualify long strip-filters components compliant with space environment. It has demonstrated the relevance of the choice of the coating technology (material choice, coating process...) with respect to the manufacturing process and the requirements. The lift-off process has also proved to be a very successful process to manufacture different stripe-filters on the same substrate with a very accurate geometrical design.

We have also shown that the detector's geometrical definition is not a straightforward task, and that care had to be taken towards all parameters. In our case, we have tried to anticipate the problems at the instrument level. This has lead to a detector definition partially driven by internal straylight problems as well as manufacturing considerations, but having sufficient performances at a much reasonable cost considering the global gain on the instrument.