

# International Conference on Space Optics—ICSO 2008

Toulouse, France

14–17 October 2008

*Edited by Josiane Costeraste, Errico Armandillo, and Nikos Karafolas*



## ***COBRA: a CMOS space qualified detector family covering the need for many LEO and GEO optical instruments***

*Michel Bréart de Boisanger*

*Olivier Saint-Pé*

*Franck Larnaudie*

*Saiprasad Guiry*

*et al.*



# COBRA, A CMOS SPACE QUALIFIED DETECTOR FAMILY COVERING THE NEED FOR MANY LEO AND GEO OPTICAL INSTRUMENTS

Michel Bréart de Boisanger<sup>(1)</sup>, Olivier Saint-Pé<sup>(1)</sup>, Franck Larnaudie<sup>(1)</sup>, Saiprasad Guiry,  
Pierre Magnan<sup>(2)</sup>, Philippe Martin Gonthier<sup>(2)</sup>, Franck Corbière<sup>(2)</sup>, Nicolas Huger<sup>(2)</sup>  
Neil Guyatt<sup>(3)</sup>

<sup>(1)</sup>EADS Astrium 31 Av des Cosmonautes 31402 Toulouse Cédex 4 France, michel.breartdeboisanger@astrium.eads.net

<sup>(2)</sup>ISAE-CIMI 10 Avenue Edouard Belin BP 4032 31055 Toulouse Cédex France, Pierre.magnan@isae.fr

<sup>(3)</sup>e2v, 106 Waterhouse Lane, Chelmsford, Essex, CM1 2QU, England, Neil.Guyatt@e2v.com

## ABSTRACT

Visible and NIR space imaging applications are today taking advantage from the availability of CMOS arrays offering excellent electro-optics performances thanks to the use of processes dedicated to imaging applications. Astrium and ISAE have developed a family of CMOS detector based on UMC 0.35 microns foundry from a sound R&T program which has enabled the design a wide toolbox and subsequent qualification of associated technology bricks. From these elements, many detectors were developed, among them a 2 Million pixels detector was fully space qualified in 2007. This will be one of the first CMOS detector operated in an operational mission on the geostationary orbit. The back-end processing of COBRA 2M was carried out to e2v technologies. e2v will also industrialize the multi linear sensor of the Multi Spectral Instrument of the low Earth orbit Sentinel 2 mission for which COBRA family was selected. Performances and qualification results will be presented in this paper as well as the development of test benches to improve accuracy and efficiency for extensive detectors characterisation and advanced technology works to extend the COBRA family capabilities.

## 1. INTRODUCTION

Fig. 1-1 illustrates the COBRA detector roadmap conducted from 2002 to 2007 to produce both space qualified 2D and multi linear arrays, with high Spectral Detection Efficiency, for GEO and LEO Earth observation missions. Four main goals were reached during these years: high electro-optical performances, linear swing improvement, low noise readout by pixel Correlated Double Sampling and conversion gain adjustment.

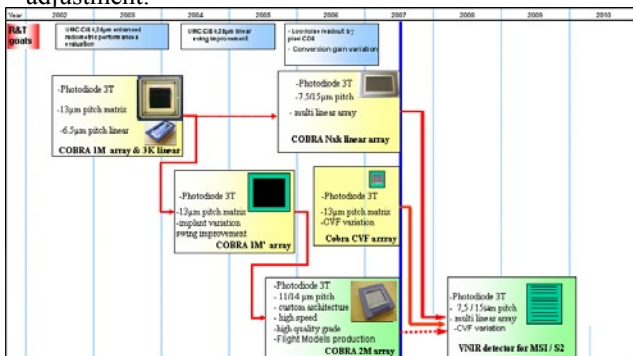

Fig. 1-1: UMC 0.35µm COBRA family roadmap

## 2. COBRA2M: A 2 MILLIONS PIXELS DETECTOR FULLY SPACE QUALIFIED IN 2007 FOR AN OPERATIONAL GEOSTATIONARY OCEAN COLOUR MISSION

### 2.1 Geostationary Ocean Color Mission [1]

The detector COBRA2M has been developed for the Geostationary Ocean Color Instrument (GOCI), see Fig. 2-1, implemented on the COMS spacecraft to provide multi-spectral data to detect, monitor, quantify, and predict short term changes of coastal ocean environment around Korea, see Fig. 2-2, for marine science research and application purpose, in eight spectral narrow bands, see Fig. 2-3.

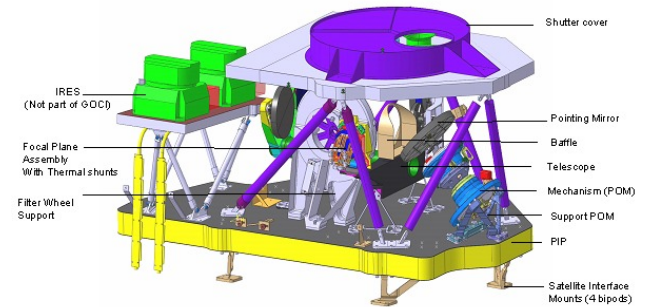

Fig. 2-1: Geostationary Ocean Color instrument (GOCI) implemented on COMS Satellite Interface.

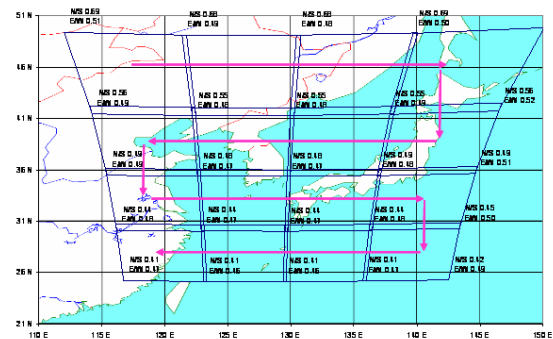

Fig.2-2: GOCI Target Area Around Korea in COMS Application:16 Slots are used to cover 2500\*2500 Km2

Band	center	Bandwidth	Main Purpose
1	412 nm	20 nm	Yellow substance and turbidity extraction
2	443 nm	20 nm	Chlorophyll absorption maximum
3	490 nm	20 nm	Chlorophyll and other pigments
4	555 nm	20 nm	Turbidity, suspended sediment
5	660 nm	20 nm	Baseline of fluorescence signal, chlorophyll, suspended sediment
6	680 nm	10 nm	Atmospheric correction and fluorescence signal
7	745 nm	20 nm	Atmospheric correction and baseline of fluorescence signal
8	865 nm	40 nm	Aerosol optical thickness, vegetation, water vapor reference over the

Fig. 2-3: GOCI spectral bands and main purpose.

## 2.2 Detector heritage

### 2.2.1 Array heritage

A prototype of 1 million pixels was developed in 2002-2004 to confirm UMC 0.35 $\mu$ m excellent radiometric performances [2] in term of Spectral Detection Efficiency (SDE) and Modulation Transfer Function (MTF), see Fig. 2-4 and 2-5.

A new prototype COBRA1MP with various ionic implantations was tested in 2005 to maximize output voltage swing [3], offering improved charge handling capacity necessary for photonic noise dominated application as Geostationary Ocean Colour Imaging

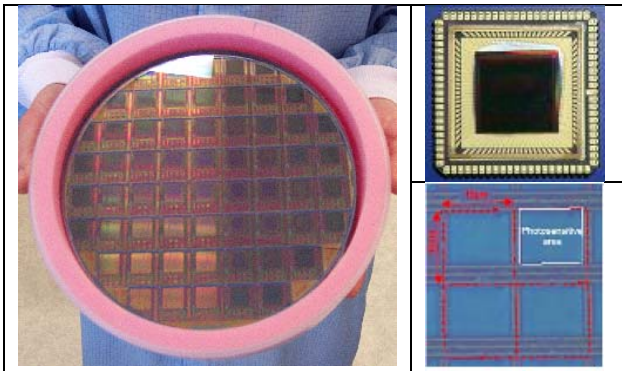

Fig. 2-4: COBRA 1M device): 8 inch wafer (left); COBRA1M in package (top right); COBRA1M pixels (bottom right).

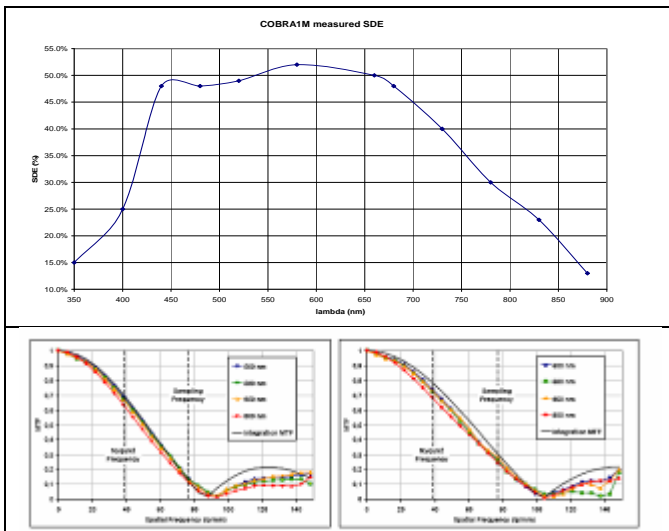

Fig. 2-5: COBRA 1M performances

### 2.2.2 Packaging heritage

Experience gained in the frame of LOLA mission [4] with the development of a 750x750 airborne APS [5] was used to define the COBRA2M package, using the same concept of Interstitial Pin Grid Array (IPGA) connected to a PCB Flex with multiple flexible parts, see Fig. 2.6, anticipating a Focal Plane Array with the detector back glued on a SiC part to offer excellent thermal control.

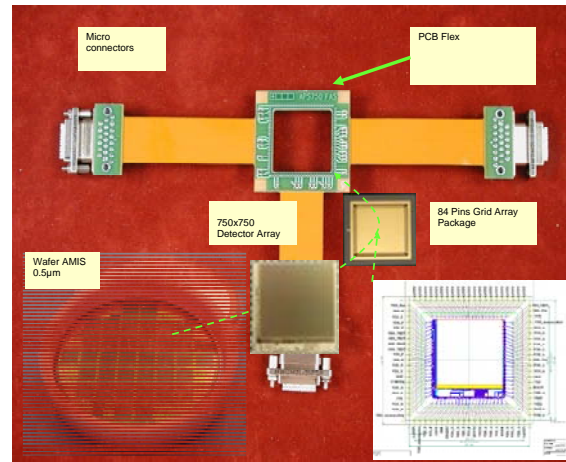

Fig. 2-6: LOLA APS750FAST packaging

## 2.3 Detector development

### 2.3.1 Design phase

From the radiometric performances extrapolated from COBRA1M and the increased performances of the readout circuit in term of output voltage swing, tested on COBRA1MP, accurate modelling of the COBRA2M performances was possible, especially in term of elementary integration time and the number of cumulated images necessary to meet specified SNR of 1000 for each of the eight spectral bands.

For the band of maximum flux and maximum Spectral Detection Efficiency, a minimum elementary integration time of 100msec was necessary to collect 100ke-. The frame period for this value is 100msec and was provided by four outputs with a pixel rate of 5.3 MPixels/sec.

Row and column decoders, already developed in the frame of COBRA1M, were implemented, see Fig. 2-7.

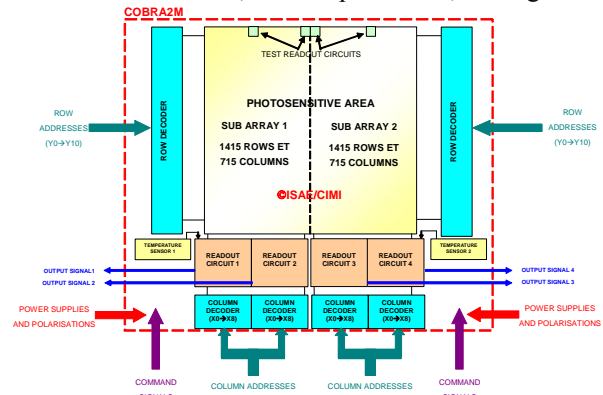

Fig. 2-7: COBRA2M Detector Architecture

### 2.3.2 Demonstrator Model (DM) manufacturing and test phase

A small number of devices were packaged by e2v and tested by Astrium.

Readout circuit performances were confirmed with respect to COBRA 1M\_P test results, see Fig. 2-8, with an output voltage swing greater than 1.1V for a 3.3V power supply and a Readout noise in darkness of 500 $\mu$ V rms due to  $\sqrt{2kT/C}$  hard reset noise and an estimated 200 $\mu$ V rms noise for sampling circuit.

MTF performances measured on COBRA1M were confirmed, using a specific Astrium test bench, see Fig. 2-9

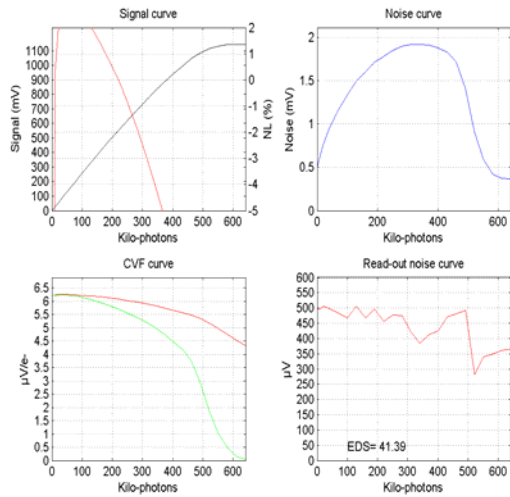

Fig. 2-8: readout circuit and radiometric performances of output 1 at 550nm

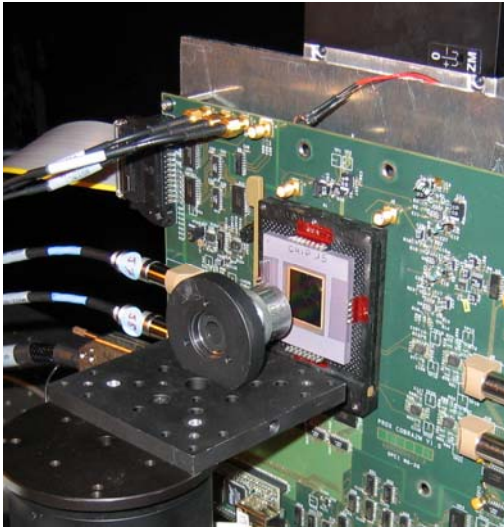

Fig. 2-9: COBRA2M on MTF test bench

At the end of the DM phase, a COBRA2M device was soldered to a PCB Flex and connected to the Front End Electronic (FEE) to test compatibility, see Fig. 2-10. Electro-optical tests were repeated to validate FEE behaviour.

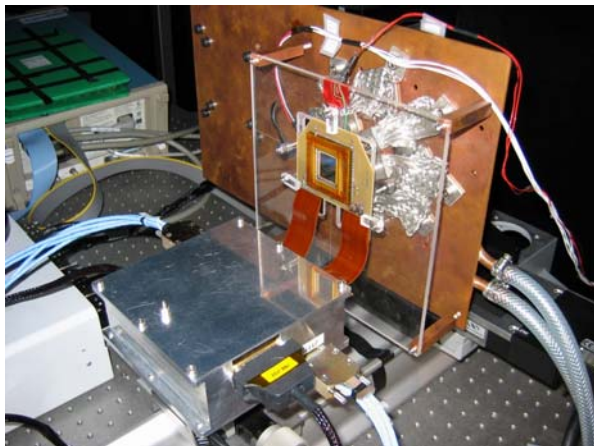

Fig. 2-10: Detector-Front End Electronic coupling on COBRA thermal controlled test bench

### 2.3.3 Flight Model (FM) manufacturing and qualification phase

DM test results presented at the Critical Design Review (CDR) authorized the FM manufacturing and qualification phase. A FM test bench was implemented in an Astrium clean room, see Fig. 2.11 to screen the 32 devices packaged and delivered by e2v and select Qualification models, Flight model and Flight spares, see Fig. 2.12. The qualification test results demonstrated only Dark Current increases with Total Ionizing Dose (5krad) and protons irradiations ( $2 \cdot 10^{10} p+/cm^2$  60MeV) as depicted in figure 2.13.



Fig. 2-11: COBRA2M FM test bench in clean room with class 100 flux and device regulated at 17°C.

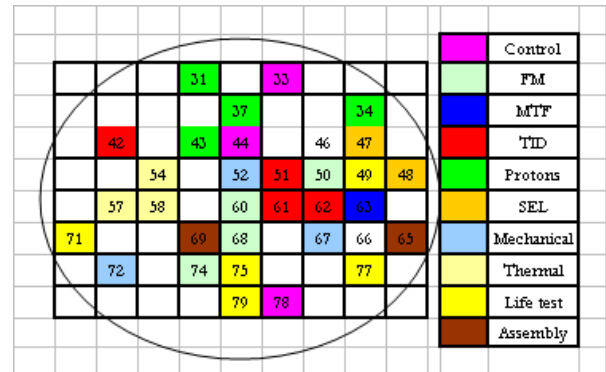

Fig. 2-12: location of Qualification and Flight Models on the wafer processed by e2v.

N°	Characteristics	Symbol	Unit	FM37		
				Meas. Before	Meas. After	Meas. Diff
1	Supply current (total)	IDD	mA	13.74	13.79	0.40%
Video Signal Characteristics B5						
4	Mean Charge to Voltage Factor	CVF	μV/e-	6.03	5.99	0.70%
5	Mean Voltage at 1% of non linearity	V1%	mV	648	642	0.90%
6	Mean Voltage at 5% of linearity	V5%	mV	871	866	0.50%
7	Mean Saturation Voltage	Vsat	mV	1125	1125	0.00%
<b>Performance in Darkness</b>						
8	Mean Dark Signal	DS	nA/cm <sup>2</sup>	0.23	0.3	30%
9	Dark Signal Non Uniformity	DSNU	%	2.34	2.52	7.70%
10	Mean Noise in Darkness	Yn	μV	541	531	2.00%
11	Offset in Darkness	FPN	mV	-2.3	-1.9	
<b>Mean SDE over 2 millions pixels</b>						
12	B1	SDE_B1	%	30.5	30.5	-0.10%
13	B2	SDE_B2	%	35.9	36.1	-0.60%
14	B3	SDE_B3	%	45	45.2	-0.50%
15	B4	SDE_B4	%	42.2	42.2	0.00%
16	B5	SDE_B5	%	40.6	40.4	0.50%
17	B6	SDE_B6	%	35.4	35.7	-0.90%
18	B7	SDE_B7	%	27.4	27.1	1.10%
19	B8	SDE_B8	%	12.2	12.3	-0.20%

Fig. 2-13: electro-optical parameters before after proton irradiation ( $2 \cdot 10^{10} p+/cm^2$  60MeV).

### 2.2.4 COBRA2M development lessons learnt

A learning curve is always necessary when using a new foundry and that some prototypes are necessary before producing flight models. Developing an efficient fully

automated test bench greatly assists the conduction of testing during an FM production phase, securing both schedule and quality of test results, especially for the repeatability of test before and after qualification tests. The selected Flight Model was delivered in June 2007, (two years after project kick off), to be soldered on the Flight PCB Flex and then glued onto the Focal Plane Array Sic part, before to be mounted on the Instrument telescope.

### 3. S2 VNIR: A MULTI LINEAR SENSOR OF THE MULTI SPECTRAL INSTRUMENT (MSI) FOR THE LOW EARTH ORBIT SENTINEL 2 MISSION [6]

#### 3.1 Sentinel 2 mission, instrument and VNIR focal plane

Sentinel 2 is a LEO Earth observation mission in the frame of Global Measurement Environment and Security (GMES) program. The instrument is equipped with VNIR and SWIR Focal Plane Arrays, Each Focal Plane Array is made of twelve detectors in staggered configuration, see Fig. 3-1. The VNIR detector offers tens spectral bands with 10m, 20m and 60m resolution, and the SWIR detector offers three spectral bands with 20m and 60m resolution, see Fig. 3-2.

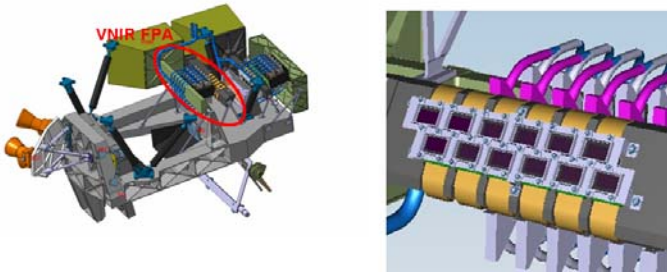

Fig. 3-1: sentinel 2 MSI instrument (left) and associated VNIR focal plane (right)

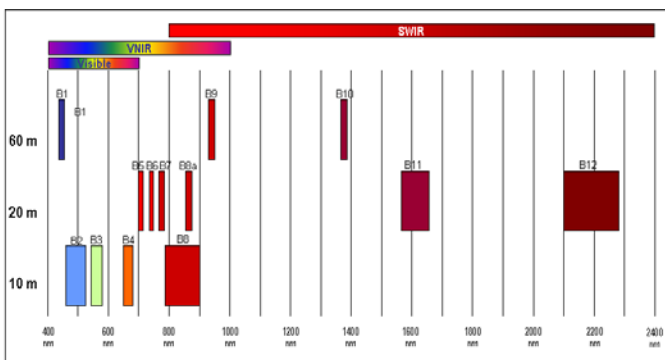

Fig. 3-2: 13 spectral bands versus spatial sampling distance for VNIR and SWIR detectors on board S2 mission.

For each spectral band, a SNR corresponding to a reference flux and the maximum integration time is specified. A maximum flux is also specified for each spectral band. The detector sensitivity has to be adjusted band per band through Charge to Voltage conversion Factor (CVF) adjustment to meet SNR specification for a reference flux with avoiding saturation for maximum flux.

To help meeting SNR requirement, a Correlated Double Sampling readout circuit is implemented to eliminate photodiode reset noise and provide total readout noise lower than 200 $\mu$ V

#### 3.2 Detector heritage

##### 3.2.1 Array heritage

A multi linear array prototype COBRA NxK providing two lines with 10m resolution and nine lines with 20m resolution associated to two outputs was developed and tested in 2006 and beginning of 2007, see Fig. 3-3.

This prototype validates the Correlated Double Sampling readout circuit with the expected readout noise reduction, due to photodiode reset noise suppression.

Specific test vehicles (COBRA CVF) were developed and tested to validate conversion gain adjustment.

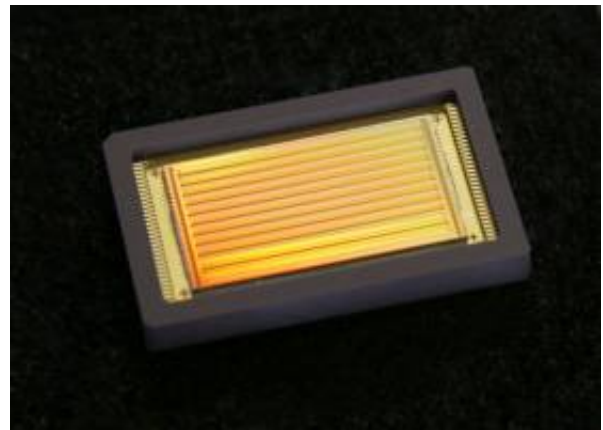

Fig. 3-3: COBRA NxK prototype

##### 3.2.2 Test bench and method heritage

The detector development took also advantage of know-how gained in the frame of the COBRA2M development, in term of test bench architecture, definition and implementation, see Fig. 3-4.

The same test methods and processing were mastered, providing high accuracy in test results, see Fig. 3-5.

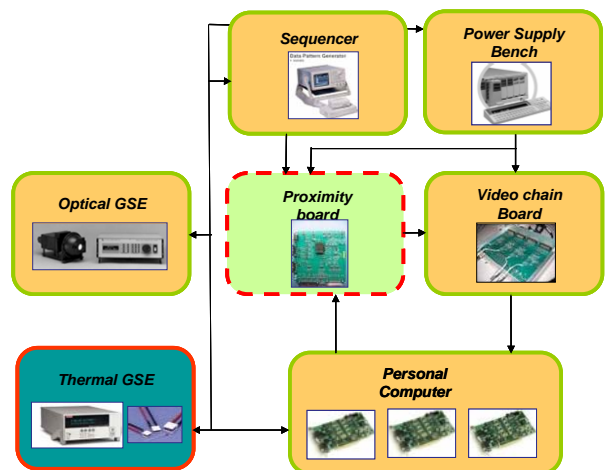

Fig. 3-4: S2 VNIR test bench architecture, using COBRA2M elements

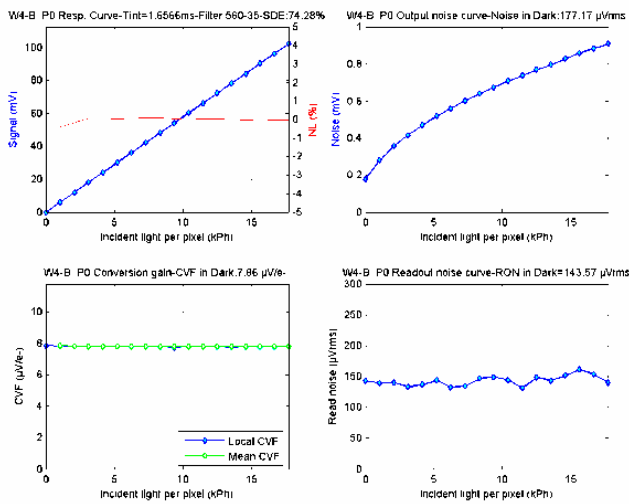

Fig. 3-5: typical SDE, CVF and RON estimation with non linear estimation method [7]

### 3.2.3 Black coating heritage

As for COBRA2M, e2v works on the S2 VNIR back end manufacturing. Due to VNIR reflectivity requirements, a post process step is needed in order to strongly reduce the die global reflectivity. A black coating will be deposit on the non photosensitive area of the die to meet reflectivity requirements. This process has been still validated on COBRA NxK wafers, although black coated COBRA NxK devices have been packaged by e2v, see Fig. 3-6. Fig. 3-7 illustrates reflectivity measurements. Very low reflectance is achieved.

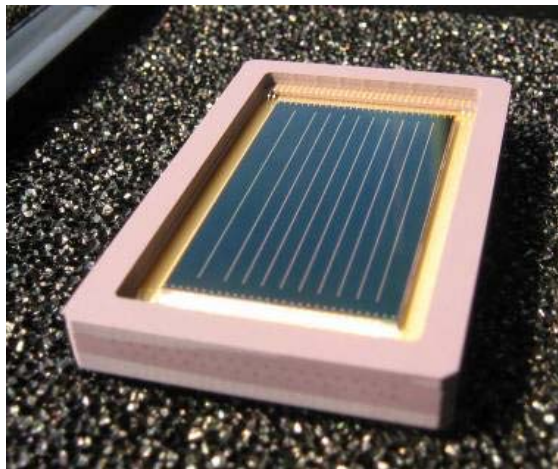

Fig. 3-6: COBRA NxK black coated device

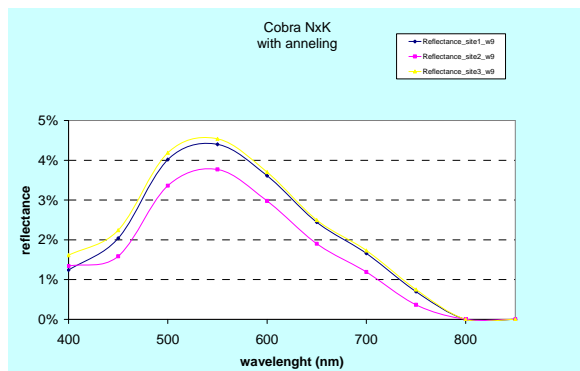

Fig. 3-7: black coating reflectivity

## 3.3 S2 VNIR Detector development status

### 3.3.1 End of Design and validation phase

Today the design and validation phase is nearing completion, concluded by a Preliminary Design Review (PDR)

Fig. 3-8 presents the retained architecture:

- Pixels lines associated to the different spectral bands are read through three outputs at a sample rate of 4.8MHz enabling to read the 10m resolution bands in less than 1.51msec
- Each group of lines associated to one output are selected by a row decoder. Readout circuit sampling capacitances are addressed by shift registers

Fig. 3-9 shows a breadboard of the S2 VNIR device using COBRA NxK die to demonstrate required photosensitive flatness better than 10µm.

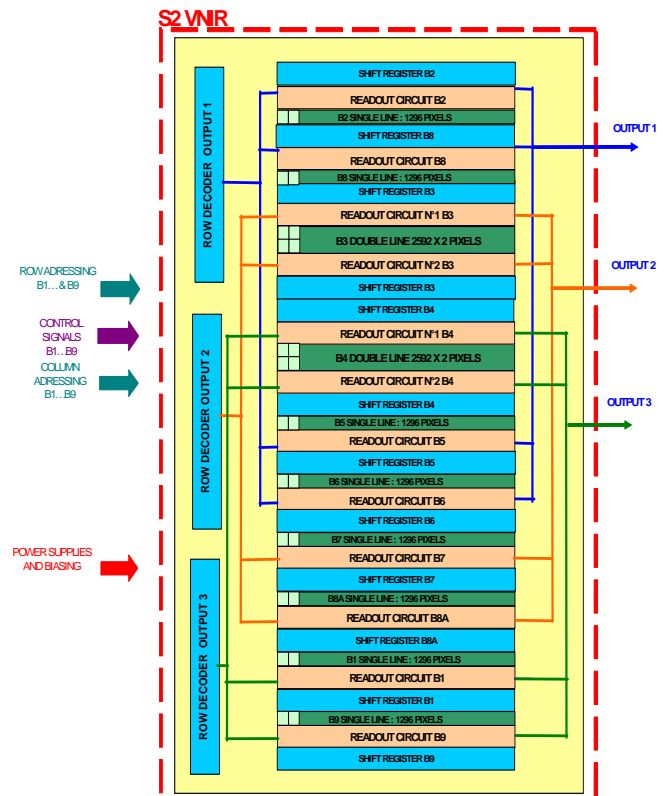

Fig. 3-8 : S2 VNIR architecture

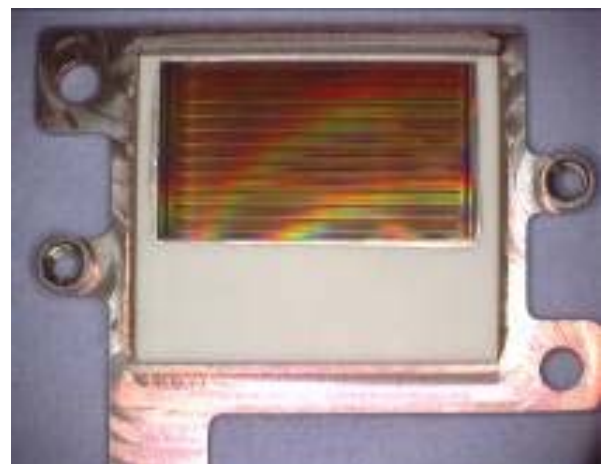

Fig. 3-9: breadboard of the S2 VNIR detector using COBRA NxK die.

### 3.3.2 EM and FM phases

Procurements of different parts: die wafers, package parts, see Fig. 3-10 and manufacturing of jigs for assembly and tests, will be initiated after PDR release.

Adaptation of test bench software and test bench acceptance are in progress, as definition of manufacturing and testing flows is established to meet schedule and quality requirements. EM phase ends with CDR in April 2009.

FM qualification and delivery is foreseen for January 2010.

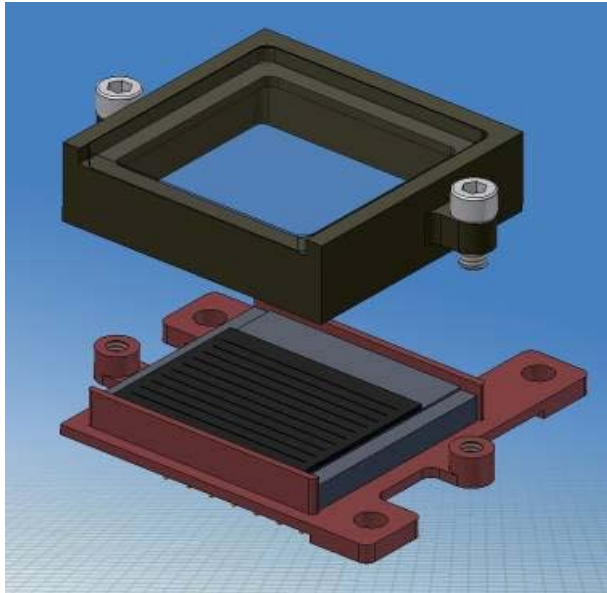

Fig. 3-10: 3D detector view; detector is equipped with a temporary window.

## 4. CONCLUSIONS

Thanks to the use of 0.35  $\mu\text{m}$  CIS process, a first generation of CIS has been developed by Astrium and ISAE/CIMI, enabling the response to the needs of space optical instruments for GEO and LEO Earth observation. Our team is today investigating several ways in order to further improve the performances of monolithic CIS, while retaining all their functional and technological advantages.

Sensitivity improvement is foreseen by thinning and backside illuminating CIS (Fig. 4-1) [8] or by use of micro lenses coupled to front side illuminated devices. For the NIR part of the spectrum; improvement is expected using silicon wafers with thicker epitaxial layers.

Larger format 2D arrays are in progress (target being about 10 millions pixels), the use of smaller nodes (e.g. 0.18  $\mu\text{m}$  process) allowing the design of smaller pixel pitches while keeping the fill factor constant. Dynamics improvement is targeted via two ways:

- Increasing the output video signal voltage swing, which can be reached thanks to low threshold voltage transistors available through modern CMOS processes.
- Reduction in the read out noise obtained by using 4T photodiodes instead on 3T ones.

Finally, on chip signal processing (within or outside the pixel) is a field that can strongly improve CMOS performances for specialised applications, such as lightning imagers, requested for future meteorological space missions.

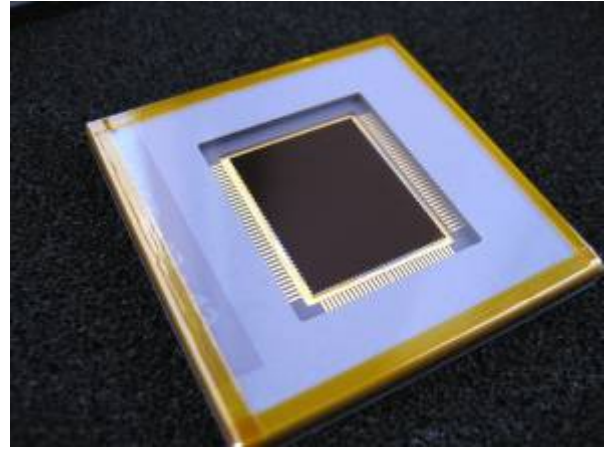

Fig. 4-1: COBRA2M thinned and backside illuminated developed by Astrium, ISAE and E2V team.

## 5. REFERENCES

1. <http://www.ioccg.org/sensors/Ahn-KORDI.pdf>
2. O Saint-Pé et al., *Research-grade CMOS image sensors for remote sensing applications*, SPIE Proceedings, Vol. 5570, 2004
3. P. Martin Gonthier et al. *Dynamic range optimisation of CMOS image sensors dedicated to space applications* SPIE proceedings Vol. 6744, 2007
4. L. Vaillon et al., *Flight results of the LOLA demonstration of optical communications between an aircraft and a GEO relay satellite*, Proc. 7th ESA International Conference on Guidance, Navigation and Control systems, Tralee, County Kerry, Ireland, June 2-5, 2008, in press
5. M. Bréart de Boisanger et al., *Développement d'un senseur d'acquisition et de poursuite (ATS) pour un terminal de liaison optique*, OPTRO 2005 conference proceedings, Paris
6. [http://www.earthobservations.org/documents/cop/ag\\_gams/gmes\\_sentinel2.pdf](http://www.earthobservations.org/documents/cop/ag_gams/gmes_sentinel2.pdf)
7. B. Pain et al. *Accurate estimation of conversion gain and quantum efficiency in CMOS imagers*, SPIE Proceedings, Vol. 5017, 2003
8. B. Pain, Proc 2005 IEEE Workshop on Charge-Coupled Devices and Advanced Image Sensors, pages 35-38